



INSTRUCTION & SAFETY MANUAL

SIL 3 Digital Output Driver, NE Loads,
Loop Powered, DIN-Rail and
Termination Board, Model D5048S



Characteristics

General Description: The single channel Loop Powered Digital Output Isolator, D5048S, is suitable for driving solenoid valves, visual or audible alarms to alert a plant operator, or other process control devices in Hazardous Area from a driving signal in Safe Area. It can also be used as a controllable supply to power measuring or process control equipment. Its use is allowed in applications requiring up to SIL 3 level (according to IEC 61508:2010 Ed. 2) in safety related systems for high risk industries.

The Safety PLC or DCS driving signal powers the field device through the D5048S, which provides isolation and is capable of monitoring the conditions of the line.

Short and open circuit diagnostic monitoring, dip-switch selectable and active when input power is present, provides LED indication and NC transistor output signaling.

When fault is detected output is de-energized until normal condition is restored. Line short and open output circuit fault detection is also reflected on the PLC / DCS input circuit providing less than 10 mA consumption. In alternative, input impedance can be set to a value always lower than 2 k Ω .

An override input, dip-switch selectable, is provided to permit a safety system to override the control signal. When enabled, a low input voltage always de-energizes the field device regardless of the input signal.

Three basic output circuits are selectable, with different safety parameters, to interface the majority of devices on the market.

The selection among the three output characteristics is obtained by connecting the field device to a different terminal block.

Mounting on standard DIN-Rail, with or without Power Bus to provide fault signal, or on customized Termination Boards, in Safe Area / Non Hazardous Location or in Zone 2 / Class I, Division 2 or Class I, Zone 2.

Functional Safety Management certification: G.M. International is certified by TUV to conform to IEC61508:2010 part 1 clauses 5-6 for safety related systems up to and included SIL3.



Technical Data

Loop Input: loop powered control signal.

Loop Supply: 24 Vdc nom (20 to 30 Vdc) reverse polarity protected, 2 A time lag fuse internally protected. Supplies also diagnostic monitoring control circuit.

Current consumption @ 24 V: 65 mA with 45 mA output typical in normal operation, \leq 10 mA when fault circuit enabled and fault condition detected.

Power dissipation: 1.1 W with 24 V supply, output energized at 45 mA nominal load.

Override Input: override control signal de-energizes output when enabled by dip-switch.

Override range: 24 Vdc nom (20 to 30 Vdc) to disable (field device controlled by input), 0 to 5 Vdc to de-energize field device, reverse polarity protected.

Current consumption @ 24 V: 15 mA max.

Isolation (Test Voltage): I.S. Out/In 2.5 KV; I.S. Out/Fault 2.5 KV; I.S. Out/Override 2.5 KV; In/Fault 500 V; In/Override 500 V; Fault/Override 500 V.

Output: 45 mA at 13.0 V (21.0 V no load, 174 Ω series resistance) at terminals 7-10 Out A.

45 mA at 10.2 V (21.0 V no load, 236 Ω series resistance) at terminals 8-10 Out B.

45 mA at 8.5 V (21.0 V no load, 275 Ω series resistance) at terminals 9-10 Out C.

Short circuit current: \geq 50 mA (55 mA typical).

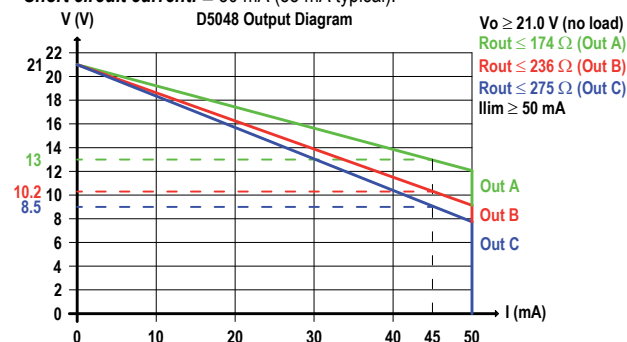

Response time: \leq 75 ms.

Fault detection: field device and wiring open circuit or short circuit detection dip-switch selectable. When fault is detected output is de-energized until normal condition is restored.

Short output detection: load resistance \leq 50 Ω (\approx 2 mA forcing to detect fault).

Open output detection: load resistance $>$ 10 k Ω .

Fault signaling: voltage free NE SPST optocoupled open-collector transistor (output de-energized in fault condition and when input power not present).

Open-collector rating: 100 mA at 35 Vdc (\leq 1.5 V voltage drop).

Leakage current: \leq 50 μ A at 35 Vdc.

Input impedance: $I_{in} <$ 10 mA when fault detected or $R_{in} <$ 2 k Ω (dip-switch selectable).

Response time: \leq 75 ms.

Compatibility:

CE CE mark compliant, conforms to Directive: 2014/34/EU ATEX, 2014/30/EU EMC, 2014/35/EU LVD, 2011/65/EU RoHS.

Environmental conditions:

Operating: temperature limits -40 to $+70$ $^{\circ}$ C, relative humidity 95 %, up to 55 $^{\circ}$ C.

Storage: temperature limits -45 to $+80$ $^{\circ}$ C.

Safety Description:



ATEX: II 3(1)G Ex nA [ia Ga] IIC T4 Gc, II (1) D [Ex ia Da] IIIC, I (M1) [Ex ia Ma] I

IECEx / INMETRO / NEPSI: Ex nA [ia Ga] IIC T4 Gc, [Ex ia Da] IIIC, [Ex ia Ma] I,

UL: NI / I / 2 / ABCD / T4, AIS / I, II, III / 1 / ABCDEFG, AEx nA [ia Ga] IIC T4 Gc

C-UL: NI / I / 2 / ABCD / T4, AIS / I, II, III / 1 / ABCDEFG, Ex nA [ia Ga] IIC T4 Gc

FM: NI-AIS / I / 2 / ABCD / T4, AIS / I, II, III / 1 / ABCDEFG, I / 2 / AEx nA [ia] / IIC / T4

FMC: NI-AIS / I / 2 / ABCD / T4, AIS / I, II, III / 1 / ABCDEFG, I / 2 / Ex nA [ia] / IIC / T4

EAC-EX: 2ExnA[ia]IIC T4 X

UKR TR n. 898: 2ExnAiaIIC T4 X, Exial X

associated apparatus and non-sparking electrical equipment.

$U_o/V_o = 24.8$ V, $I_o/I_s = 147$ mA, $P_o/P_i = 907$ mW at terminals 7-10 Out A.

$U_o/V_o = 24.8$ V, $I_o/I_s = 108$ mA, $P_o/P_i = 667$ mW at terminals 8-10 Out B.

$U_o/V_o = 24.8$ V, $I_o/I_s = 93$ mA, $P_o/P_i = 571$ mW at terminals 9-10 Out C.

$U_m = 250$ Vrms, -40 $^{\circ}$ C $\leq T_a \leq 70$ $^{\circ}$ C.

Approvals:

BVS 10 ATEX E 113 X conforms to EN60079-0, EN60079-11, EN60079-15.

IECEx BVS 10.0072 X conforms to IEC60079-0, IEC60079-11, IEC60079-15.

INMETRO DNV 13.0109 X conforms to ABNT NBR IEC60079-0, ABNT NBR IEC60079-11, ABNT NBR IEC60079-15, ABNT NBR IEC60079-26.

UL & C-UL E222308 conforms to UL913, UL 60079-0, UL60079-11, UL60079-15, ANSI/ISA 12.12.01 for UL

and CSA-C22.2 No.157-92, CSA-E60079-0, CSA-E60079-11, CSA-C22.2 No. 213 and CSA-E60079-15 for C-UL.

FM 3046304 and FMC 3046304C conforms to Class 3600, 3610, 3611, 3810,

ANSI/ISA-60079-0, ANSI/ISA-60079-11, ANSI/ISA-60079-15, C22.2 No.142, C22.2 No.157, C22.2 No.213, C22.2 No. 60079-0, C22.2 No. 60079-11, C22.2 No. 60079-15.

C-IT.ME92.B.00206 conforms to GOST 30852.0, 30852.10, 30852.14.

CJ 16.0036 X conforms to DCTY 7113, GOCT 22782.5-78, DCTY IEC 60079-15.

GYJ14.1406X conforms to GB3836.1, GB3836.4; GB3836.8, GB3836.20.

TQ21109 for TIIS approval.

TUV Certificate No. C-IS-236198-04, SIL 3 conforms to IEC61508:2010 Ed.2.

TUV Certificate No. C-IS-236198-09, SIL 3 Functional Safety Certificate conforms to IEC61508:2010 Ed.2, for Management of Functional Safety.

DNV Type Approval Certificate No.A-13625 and KR No.ML20769-EL002 Certificates for maritime applications.

Mounting:

T35 DIN-Rail according to EN50022, with or without Power Bus or on customized Termination Board.

Weight: about 130 g.

Connection: by polarized plug-in disconnect screw terminal blocks to accommodate terminations up to 2.5 mm².

Location: installation in Safe Area/Non Hazardous Locations or Zone 2, Group IIC T4 or Class I, Division 2, Group A,B,C,D, T4 or Class I, Zone 2, Group IIC, T4.

Protection class: IP 20.

Dimensions: Width 12.5 mm, Depth 123 mm, Height 120 mm.

Ordering information

Model: D5048S

Power Bus and DIN-Rail accessories:
Connector JDFT049
Terminal block male MOR017

Cover and fix MCHP196
Terminal block female MOR022

Front Panel and Features

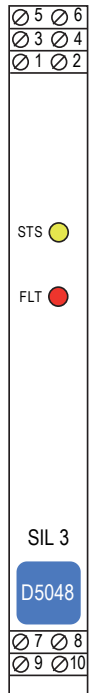

- SIL 3 according to IEC 61508:2010 Ed. 2 for life time = 20 years.
- PFDavg (1 year) 0.00 E+00, SFF 100 %.
- SIL 3 Systematic capability
- Output to Zone 0 (Zone 20), installation in Zone 2.
- Loop powered for NE loads.
- Short and open circuit line diagnostic monitoring with LED, transistor output and current level on input.
- Output short circuit proof and current limited.
- Three port isolation, Input/Output/Fault.
- EMC Compatibility to EN61000-6-2, EN61000-6-4, EN61326-1, EN61326-3-1 for safety system.
- In-field programmability by DIP Switch.
- ATEX, IECEx, UL & C-UL, FM, FMC, INMETRO, EAC-EX, UKR TR n. 898, NEPSI, TIIS, TÜV Certifications.
- TÜV Functional Safety Certification.
- Type Approval Certificate DNV and KR for maritime applications.
- Simplified installation using standard DIN-Rail and plug-in terminal blocks, with or without Power Bus, or customized Termination Boards.
- 250 Vrms (Um) max. voltage allowed to the instruments associated with the barrier.

Terminal block connections

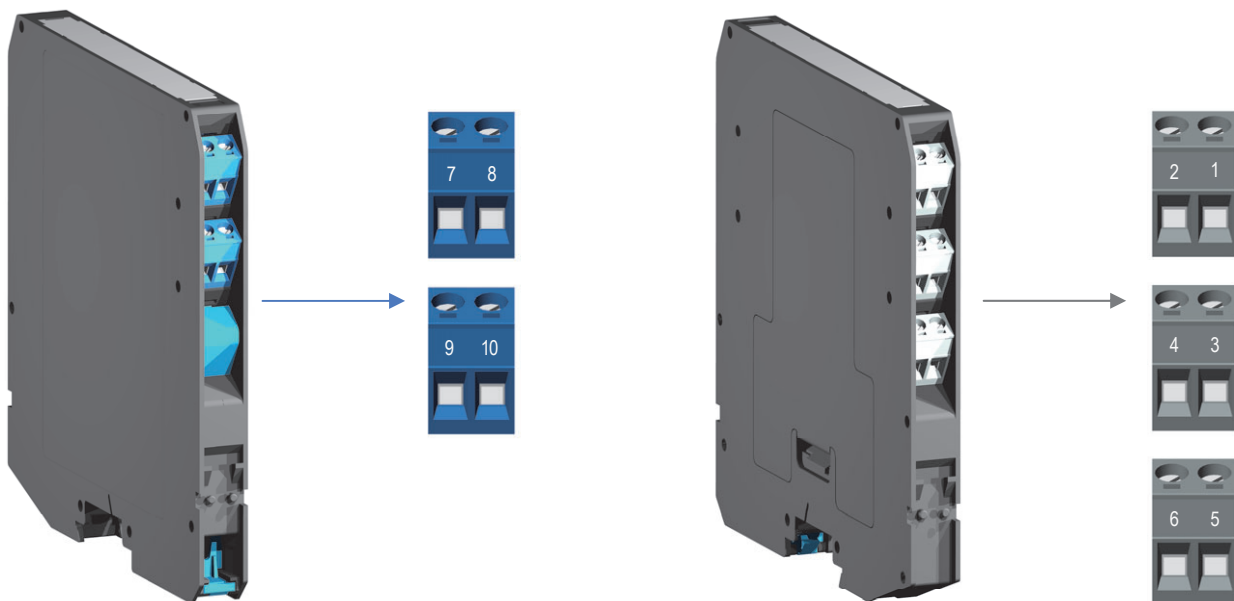

HAZARDOUS AREA

- | | |
|-----------|-------------------------------|
| 7 | + Output A for Solenoid Valve |
| 8 | + Output B for Solenoid Valve |
| 9 | + Output C for Solenoid Valve |
| 10 | - Output for Solenoid Valve |

SAFE AREA

- | | |
|----------|---------------------------|
| 1 | + Control Input |
| 2 | - Control Input |
| 3 | + Transistor Fault Output |
| 4 | - Transistor Fault Output |
| 5 | + Input Override |
| 6 | - Input Override |

Parameters Table

In the system safety analysis, always check the Hazardous Area/Hazardous Locations devices to conform with the related system documentation, if the device is Intrinsically Safe check its suitability for the Hazardous Area/Hazardous Locations and group encountered and that its maximum allowable voltage, current, power (U_i/V_{max} , I_i/I_{max} , P_i/P_i) are not exceeded by the safety parameters (U_o/V_{oc} , I_o/I_{sc} , P_o/P_o) of the D5048 series Associated Apparatus connected to it. Also consider the maximum operating temperature of the field device, Check that added connecting cable and field device capacitance and inductance do not exceed the limits (C_o/C_a , L_o/L_a , L_o/R_o) given in the Associated Apparatus parameters for the effective group. See parameters indicated in the table below:

D5048 Terminals		D5048 Associated Apparatus Parameters		Must be	Hazardous Area/ Hazardous Locations Device Parameters
Out A	7 - 10	$U_o / V_{oc} = 24.8 \text{ V}$		\leq	U_i / V_{max}
Out B	8 - 10				
Out C	9 - 10				
Out A	7 - 10	$I_o / I_{sc} = 147 \text{ mA}$		\leq	I_i / I_{max}
Out B	8 - 10				
Out C	9 - 10				
Out A	7 - 10	$P_o / P_o = 907 \text{ mW}$		\leq	P_i / P_i
Out B	8 - 10				
Out C	9 - 10				
D5048 Terminals		D5048 Associated Apparatus Parameters Cenelec (US)		Must be	Hazardous Area/ Hazardous Locations Device + Cable Parameters
Out A	7 - 10	$C_o / C_a = 113 \text{ nF}$	IIC (A, B)	\geq	$C_i / C_i \text{ device} + C \text{ cable}$
		$C_o / C_a = 860 \text{ nF}$	IIB (C)		
		$C_o / C_a = 3.05 \text{ }\mu\text{F}$	IIA (D)		
		$C_o / C_a = 4.35 \text{ }\mu\text{F}$	I		
		$C_o / C_a = 860 \text{ nF}$	IIIC (E, F, G)		
Out B	8 - 10	$C_o / C_a = 113 \text{ nF}$	IIC (A, B)	\geq	$C_i / C_i \text{ device} + C \text{ cable}$
		$C_o / C_a = 860 \text{ nF}$	IIB (C)		
		$C_o / C_a = 3.05 \text{ }\mu\text{F}$	IIA (D)		
		$C_o / C_a = 4.32 \text{ }\mu\text{F}$	I		
		$C_o / C_a = 860 \text{ nF}$	IIIC (E, F, G)		
Out C	9 - 10	$C_o / C_a = 113 \text{ nF}$	IIC (A, B)	\geq	$C_i / C_i \text{ device} + C \text{ cable}$
		$C_o / C_a = 860 \text{ nF}$	IIB (C)		
		$C_o / C_a = 3.05 \text{ }\mu\text{F}$	IIA (D)		
		$C_o / C_a = 4.35 \text{ }\mu\text{F}$	I		
		$C_o / C_a = 860 \text{ nF}$	IIIC (E, F, G)		
Out A	7 - 10	$L_o / L_a = 0.04 \text{ mH}$	IIC (A, B)	\geq	$L_i / L_i \text{ device} + L \text{ cable}$
		$L_o / L_a = 6.63 \text{ mH}$	IIB (C)		
		$L_o / L_a = 13.27 \text{ mH}$	IIA (D)		
		$L_o / L_a = 21.78 \text{ mH}$	I		
		$L_o / L_a = 6.63 \text{ mH}$	IIIC (E, F, G)		
Out B	8 - 10	$L_o / L_a = 1.42 \text{ mH}$	IIC (A, B)	\geq	$L_i / L_i \text{ device} + L \text{ cable}$
		$L_o / L_a = 12.30 \text{ mH}$	IIB (C)		
		$L_o / L_a = 24.60 \text{ mH}$	IIA (D)		
		$L_o / L_a = 40.35 \text{ mH}$	I		
		$L_o / L_a = 12.30 \text{ mH}$	IIIC (E, F, G)		
Out C	9 - 10	$L_o / L_a = 2.54 \text{ mH}$	IIC (A, B)	\geq	$L_i / L_i \text{ device} + L \text{ cable}$
		$L_o / L_a = 16.7 \text{ mH}$	IIB (C)		
		$L_o / L_a = 33.5 \text{ mH}$	IIA (D)		
		$L_o / L_a = 55.09 \text{ mH}$	I		
		$L_o / L_a = 16.7 \text{ mH}$	IIIC (E, F, G)		

Out A	7 - 10	Lo / Ro = 39.2 μ H/ Ω	IIC (A, B)	≥	Li / Ri device and L cable / R cable
		Lo / Ro = 156.8 μ H/ Ω	IIB (C)		
		Lo / Ro = 313.6 μ H/ Ω	IIA (D)		
		Lo / Ro = 514.6 μ H/ Ω	I		
		Lo / Ro = 156.8 μ H/ Ω	IIIC (E, F, G)		
Out B	8 - 10	Lo / Ro = 53.3 μ H/ Ω	IIC (A, B)	≥	Li / Ri device and L cable / R cable
		Lo / Ro = 213.5 μ H/ Ω	IIB (C)		
		Lo / Ro = 427.0 μ H/ Ω	IIA (D)		
		Lo / Ro = 700.6 μ H/ Ω	I		
		Lo / Ro = 213.5 μ H/ Ω	IIIC (E, F, G)		
Out C	9 - 10	Lo / Ro = 62.3 μ H/ Ω	IIC (A, B)	≥	Li / Ri device and L cable / R cable
		Lo / Ro = 249.4 μ H/ Ω	IIB (C)		
		Lo / Ro = 498.9 μ H/ Ω	IIA (D)		
		Lo / Ro = 818.5 μ H/ Ω	I		
		Lo / Ro = 249.4 μ H/ Ω	IIIC (E, F, G)		

For installations in which both the Ci and Li of the Intrinsically Safe apparatus exceed 1 % of the Co and Lo parameters of the Associated Apparatus (excluding the cable), then 50 % of Co and Lo parameters are applicable and shall not be exceeded (50 % of the Co and Lo become the limits which must include the cable such that Ci device + C cable \leq 50 % of Co and Li device + L cable \leq 50 % of Lo).

If the cable parameters are unknown, the following value may be used: Capacitance 180pF per meter (60pF per foot), Inductance 0.60 μ H per meter (0.20 μ H per foot).

Function Diagram

HAZARDOUS AREA ZONE 0 (ZONE 20) GROUP IIC,
HAZARDOUS LOCATIONS CLASS I, DIVISION 1, GROUPS A, B, C, D,
CLASS II, DIVISION 1, GROUPS E, F, G, CLASS III, DIVISION 1,
CLASS I, ZONE 0, GROUP IIC

SAFE AREA, ZONE 2 GROUP IIC T4,
NON HAZARDOUS LOCATIONS, CLASS I, DIVISION 2,
GROUPS A, B, C, D T-Code T4, CLASS I, ZONE 2, GROUP IIC T4

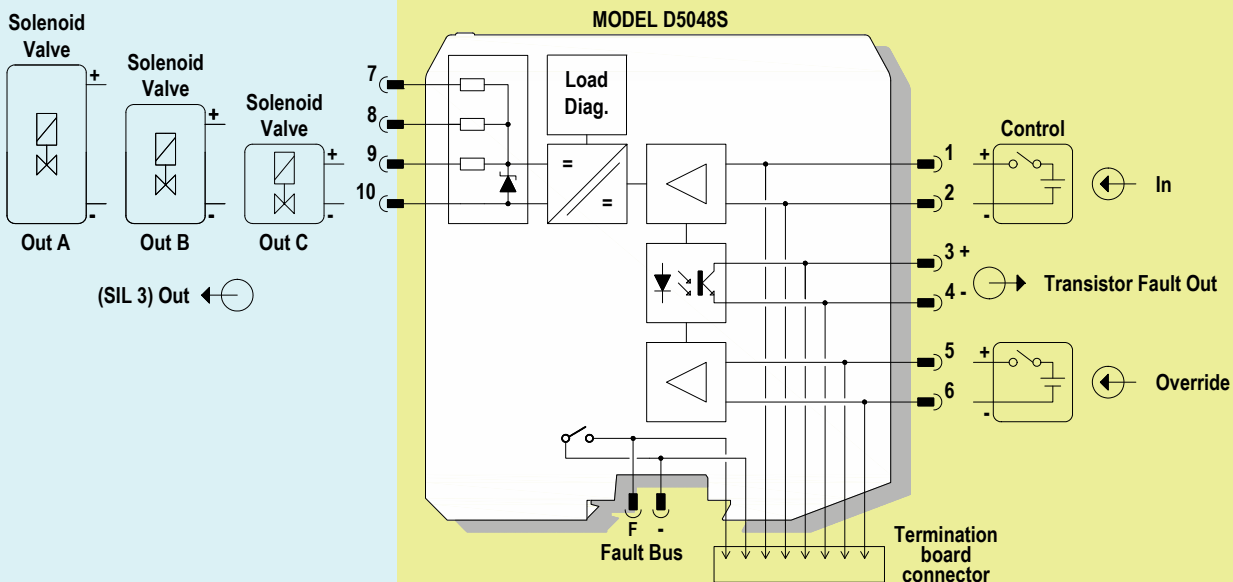

NOTE: Use only one output at a time
(Out A or Out B or Out C).

Application of D5048S for NE load

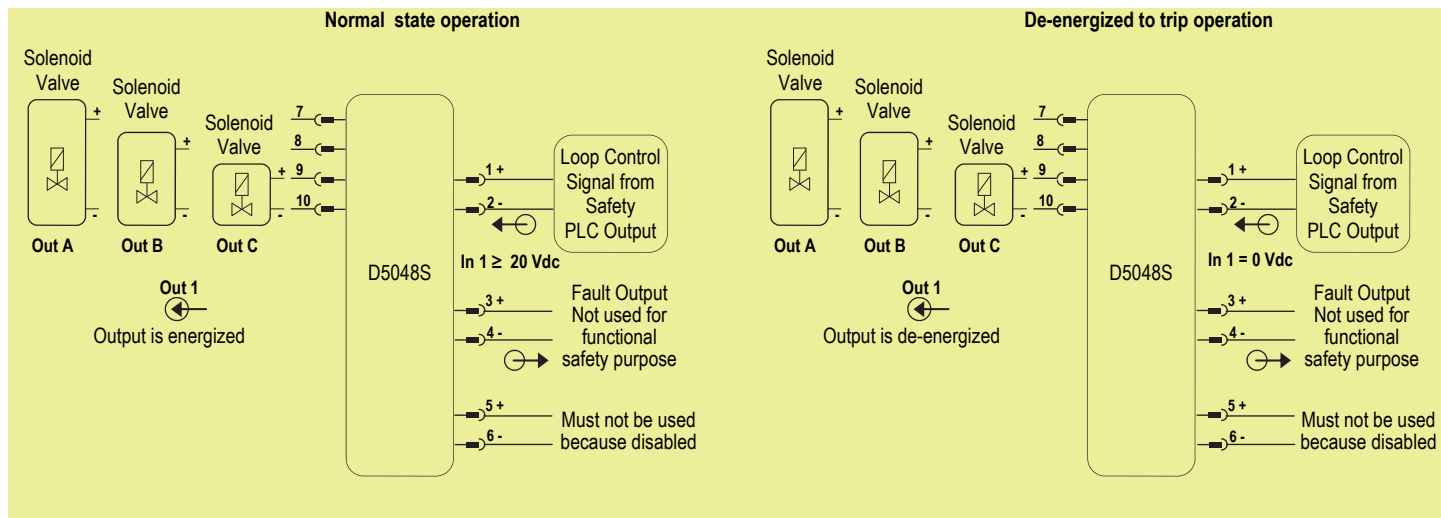

Description:

The D5048S is a single channel digital output drivers, loop powered for NE (Normally Energized) loads. The Safety PLC or DCS driving/control signals power the field devices through the single channel digital output driver D5048S (1 intrinsic safety channel, Loop Powered), which provides the electrical isolation between Input and Output. The presence of the input loop signal is also indicated by a yellow LED on the front panel.

In order to interface the majority of field devices available on the market, two basic output circuits with different safety parameters (outputs A, B and C) are provided for channel. The selection among the three output characteristics is obtained by connecting the field devices to a different couple of terminal blocks.

The field line and load fault detection is enabled, the override input is disabled, setting the internal DIP-switches in the following modes:

SW1 Dip-switch position	1	2	3	4
ON / OFF state	ON	-	-	-

SW2 Dip-switch position	1	2	3	4
ON / OFF state	-	-	-	OFF

Loop Control signals from Safety PLC Output is applied to Pins 1 - 2.

The Output NE loads are connected to Pins 7 - 10 or 8 - 10 or 9 - 10.

The following table describes the state (de-energized or energized) of each output when its control signal is in the High or Low state:

Operation	Input Signal State Pins 1 - 2	Output State Pins 7-10 (Out A) or 8-10 (Out B) or 9-10 (Out C)
Normal	High (20 to 30 Vdc)	Energized
Trip	Low (0 Vdc)	De-energized (as safe state condition)

Safety Function and Failure behavior:

D5048S is considered to be operating in Low Demand mode, as a Type A module, having Hardware Fault Tolerance (HFT) = 0.

The failure behaviour of D5048S for NE loads is described by the following definitions:

- Fail-Safe State: it is defined as the output being de-energized;
- Fail Safe: failure mode that causes the module / (sub)system to go to the defined fail-safe state without a demand from the process;
- Fail Dangerous: failure mode that does not respond to a demand from the process (i.e. being unable to go to the defined fail-safe state), so that the output remains energized;
- Fail "No Effect": failure mode of a component that plays a part in implementing the safety function but that is neither a safe failure nor a dangerous failure. When calculating the SFF, this failure mode is not taken into account.
- Fail "Not part": failure mode of a component that is not part of the safety function but part of the circuit diagram and is listed for completeness. When calculating the SFF, this failure mode is not taken into account.

Since the loop powered module is directly supplied by the digital output of a Safety PLC, if the safety PLC imposes a shutdown state of this module, there is no additional power supply which can keep the D5048S output energized in case of an internal fault. Therefore, all internal faults have either "no effect" on the safety function or lead to the safe state, according to the Safety Function definitions.

Failure rate data: taken from Siemens Standard SN29500.

Failure rate table:

Failure category	Failure rates (FIT)
λ_{dd} = Total Dangerous Detected failures	0.00
λ_{du} = Total Dangerous Undetected failures	0.00
λ_{sd} = Total Safe Detected failures	0.00
λ_{su} = Total Safe Undetected failures	142.45
$\lambda_{tot\ safe}$ = Total Failure Rate (Safety Function) = $\lambda_{dd} + \lambda_{du} + \lambda_{sd} + \lambda_{su}$	142.45
MTBF (safety function, single channel) = $(1 / \lambda_{tot\ safe}) + MTTR$ (8 hours)	801 years
$\lambda_{no\ effect}$ = "No effect" failures	219.65
$\lambda_{not\ part}$ = "Not Part" failures	34.70
$\lambda_{tot\ device}$ = Total Failure Rate (Device) = $\lambda_{tot\ safe} + \lambda_{no\ effect} + \lambda_{not\ part}$	396.80
MTBF (device, single channel) = $(1 / \lambda_{tot\ device}) + MTTR$ (8 hours)	287 years
PFDAvg (TI = 1 year) = $\frac{1}{2} \lambda_{du} * 8760\ h$	0.00E+00

Failure rates table according to IEC 61508:2010 Ed.2 :

λ_{sd}	λ_{su}	λ_{dd}	λ_{du}	SFF
0.00 FIT	142.45 FIT	0.00 FIT	0.00 FIT	100%

Therefore, the D5048S module have SIL 3 level for lifetime of 20 years.

Systematic capability is SIL 3.

Since no dangerous undetected failures have been noted during the FMEA analysis, there is no need to perform a proof test to reveal dangerous faults which cannot be otherwise detected.

Warning

D5048S is isolated Intrinsically Safe Associated Apparatus installed into standard EN50022 T35 DIN Rail located in Safe Area or Zone 2, Group IIC, Temperature T4, Hazardous Area (according to EN/IEC60079-15) within the specified operating temperature limits Tamb -40 to +70 °C, and connected to equipment with a maximum limit for AC power supply Um of 250 Vrms.

Not to be connected to control equipment that uses or generates more than 250 Vrms or Vdc with respect to earth ground.

D5048S must be installed, operated and maintained only by qualified personnel, in accordance to the relevant national/international installation standards (e.g. IEC/EN60079-14 Electrical apparatus for explosive gas atmospheres - Part 14: Electrical installations in hazardous areas (other than mines)), following the established installation rules, particular care shall be given to segregation and clear identification of I.S. conductors from non I.S. ones.

De-energize power source (turn off power supply voltage) before plug or unplug the terminal blocks when installed in Hazardous Area or unless area is known to be nonhazardous.

Warning: substitution of components may impair Intrinsic Safety and suitability for Zone 2.

Explosion Hazard: to prevent ignition of flammable or combustible atmospheres, disconnect power before servicing or unless area is known to be nonhazardous.

Failure to properly installation or use of the equipment may risk to damage the unit or severe personal injury.

The unit cannot be repaired by the end user and must be returned to the manufacturer or his authorized representative.

Any unauthorized modification must be avoided.

Operation

The single channel Loop Powered Digital Output Isolator, D5048S, is suitable for driving solenoid valves, visual or audible alarms to alert a plant operator, or other process control devices in Hazardous Area from a driving signal in Safe Area. It can also be used as a controllable supply to power measuring or process control equipment. Its use is allowed in applications requiring up to SIL 3 level (according to IEC 61508) in safety related systems for high risk industries. The Safety PLC or DCS driving signal powers the field device through the D5048S, which provides isolation and is capable of monitoring the conditions of the line. Short and open circuit diagnostic monitoring, dip-switch selectable and active when input power is present, provides LED indication and NC transistor output signaling. When fault is detected output is de-energized until normal condition is restored. Line short and open output circuit fault detection is also reflected on the PLC / DCS input circuit providing less than 10 mA consumption. An override input, dip-switch selectable, is provided to permit a safety system to override the control signal. When enabled, a low input voltage always de-energizes the field device regardless of the input signal. Three basic output circuits are selectable, with different safety parameters, to interface the majority of devices on the market. The selection among the three output characteristics is obtained by connecting the field device to a different terminal block. Presence of output, as well as integrity or fault condition of device and connecting line are displayed by signaling LEDs (yellow for status, red for fault).

Installation

D5048S is a Digital Output Driver housed in a plastic enclosure suitable for installation on T35 DIN-Rail according to EN50022, with or without Power Bus or on customized Termination Board. D5048S unit can be mounted with any orientation over the entire ambient temperature range.

Electrical connection of conductors up to 2.5 mm² are accommodated by polarized plug-in removable screw terminal blocks which can be plugged in/out into a powered unit without suffering or causing any damage (**for Zone 2 installations check the area to be nonhazardous before servicing**).

The wiring cables have to be proportionate in base to the current and the length of the cable.

On the section "Function Diagram" and enclosure side a block diagram identifies all connections.

Identify the function and location of each connection terminal using the wiring diagram on the corresponding section, as an example:

Connect positive input at terminal "1" and negative input at "2".

Connect positive transistor fault output at terminal "3" and negative at "4".

Connect positive input override at terminal "5" and negative input at "6".

Connect positive output A for solenoid valve at terminal "7" and negative at "10" or output B at terminal "8" and negative at "10" or output C at terminal "9" and negative at "10".

Intrinsically Safe conductors must be identified and segregated from non I.S. and wired in accordance to the relevant national/international installation standards (e.g. EN/IEC60079-14 Electrical apparatus for explosive gas atmospheres - Part 14: Electrical installations in hazardous areas (other than mines)), make sure that conductors are well isolated from each other and do not produce any unintentional connection.

Connect SPST fault output transistors checking the load rating to be within the maximum rating (100 mA at 35 Vdc (≤ 1.5 V voltage drop)).

The enclosure provides, according to EN60529, an IP20 minimum degree of mechanical protection (or similar to NEMA Standard 250 type 1) for indoor installation, outdoor installation requires an additional enclosure with higher degree of protection (i.e. IP54 to IP65 or NEMA type 12-13) consistent with the effective operating environment of the specific installation.

Units must be protected against dirt, dust, extreme mechanical (e.g. vibration, impact and shock) and thermal stress, and casual contacts.

If enclosure needs to be cleaned use only a cloth lightly moistened by a mixture of detergent in water.

Electrostatic Hazard: to avoid electrostatic hazard, the enclosure of D5048S must be cleaned only with a damp or antistatic cloth.

Any penetration of cleaning liquid must be avoided to prevent damage to the unit. Any unauthorized card modification must be avoided.

Start-up

Before powering the unit check that all wires are properly connected and verify their polarity, also check that Intrinsically Safe conductors and cable trays are segregated (no direct contacts with other non I.S. conductors) and identified either by color coding, preferably blue, or by marking. Check conductors for exposed wires that could touch each other causing dangerous unwanted shorts. Activate control input, the status led must be in accordance with condition of the corresponding input line.

Configuration

A configuration DIP switches are located on component side of pcb. These switches allows the configuration of override input and fault detection functions.

D5048S

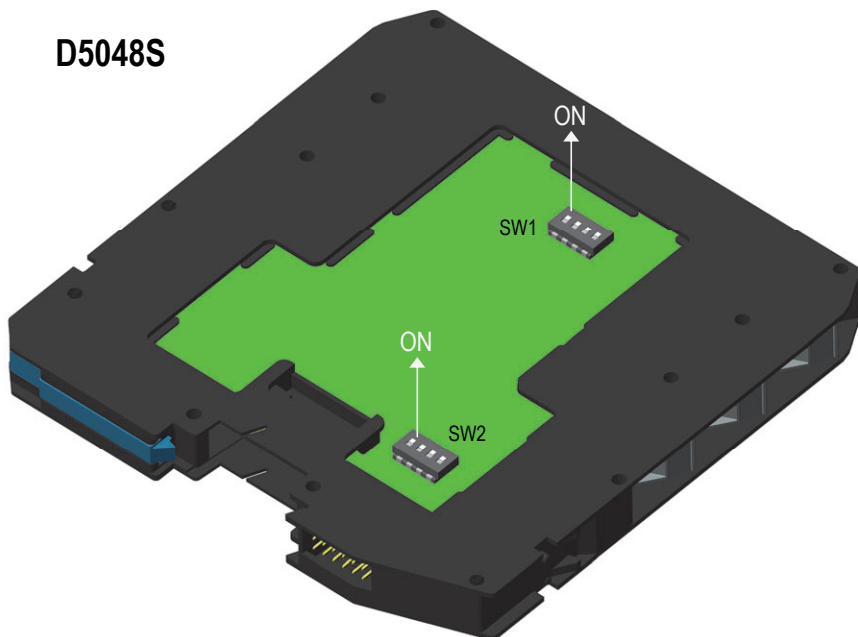

SW1 factory settings
All DIP-switches are ON

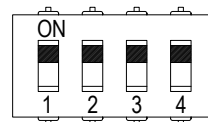

SW2 factory settings
DIP-switches 1-2-3 are ON and 4 is OFF

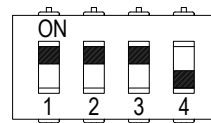

SW1 dip switch configuration

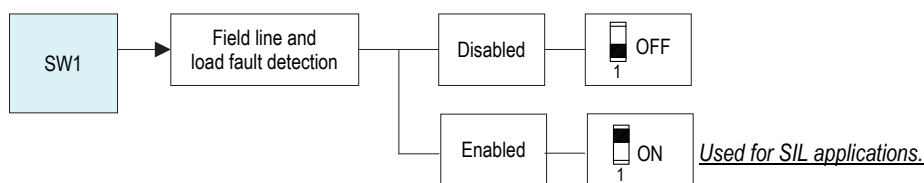
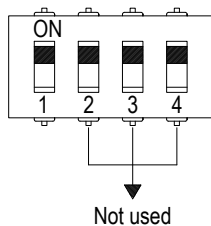

SW2 dip switch configuration

